

USER'S MANUAL

LAARMANN SIEVING SHAKER LMSM-300/450

<u>Edition</u>	<u>Month</u>	<u>Year</u>
1.	October	2014

INSTRUCTIONS MANUAL
ELECTROMAGNETIC SIEVE SHAKERS

**DO NOT ATTEMPT TO OPERATE THIS EQUIPMENT BEFORE READING AND
COMPREHENDING THE MANUAL IN ALL ITS PARTS**

We confirm that the following machine fulfills all requirements of the EG

Laarmann Group B.V.
Op het Schoor 6
6041 AV Roermond
THE NETHERLANDS

Tel +31 475 470 217
Fax +31 475 470 242
Email : info@laarmann.eu
Internet : www.laarmann.eu

GENERAL INDEX

Chapter 1	GENERAL INFORMATION
1.01	Warnings
1.02	WARNING and DANGER indications - SIGNS
1.03	Machine Identification Data
1.04	Applications
1.05	Storage
1.06	Transportation and Movement
1.07	Packaging removal

Chapter 2	TECHNICAL CHARACTERISTICS
2.01	General machine description
2.02	Dimension and weight
2.03	Electrical supply
2.04	Noise

Chapter 3	GENERAL SAFETY NORMS
3.01	General standards
3.02	Machine Safety devices and protection

Chapter 4	INSTALLATION INSTRUCTIONS
4.01	Location
4.02	Transportation and movement
4.03	Electrical connection

Chapter 5	IN FUNCTION - USE
5.01	Machine calibration – Meters - Indicators
5.02	Placement
5.03	Equipping
5.04	Specimen positioning
5.05	Switching on the equipment
5.06	Operating mode
5.07	Switching the appliance on
5.08	Switching off
5.09	Emergency stop
5.10	Start up after emergency
5.11	Programming
5.12	Test start up

Chapter 6	MAINTENANCE
6.01	Ordinary Maintenance
6.02	Extraordinary Maintenance
6.03	Authorised maintenance centres

Chapter 7	GUIDE TO RECOGNISING DAMAGE AND ANOMALIES
------------------	--

Chapter 1	GENERAL INFORMATION
------------------	----------------------------

1.01	WARNINGS
------	-----------------

USER'S MANUAL LAARMANN LMSM-300/450

The manufacturer does not accept any responsibility for direct or indirect damage to people, things or animals and use of the appliance in different conditions from those foreseen.

The manufacturer reserves the right to make changes to the documentary information or to the appliance without advance notice.

Check the machine responds to the standards in force in the state in which it has been installed.

All operations necessary for maintaining machine efficiency before and throughout use are the operator's responsibility

Carefully read the entire manual before operating the machine.

It is vital to know the information and limitations contained in this manual for correct machine use by the operator.

Interventions are only permitted if the operator is accordingly competent and trained.

The operator must be knowledgeable about machine operations and mechanisms.

The purchaser must ensure that operators are trained and aware of all the information and clarifications in the supplied documentation.

Even with such certainty the operator or user must be informed and therefore aware of potential risks when operating the machine.

Safety, reliability and optimum performance is guaranteed when using original parts.



Any tampering or modifying of the appliance (electrical, mechanical or other), which has not been previously authorised in writing by the manufacturer, is considered abusive and disclaims the constructor from any responsibility for any resulting damage.

All necessary operations to maintain the efficiency of the machine before and throughout use are the responsibility of the user.

1.02 WARNING AND DANGER INDICATIONS - SIGNS

The machine has been designed and constructed according to the current norms and consequently with mechanical and electrical safety devices designed to protect the operator or user from possible physical damage. Residual risks during use or in some intervention procedures on the device are however present. Such risks can be reduced by carefully following manual procedures, using the suggested individual protection devices and respecting the legal and safety norms in force.

This manual includes "Warning" and "Danger" indications in relevant chapters. These indications are shown with the words "Danger" or "Warning" in bold font and uppercase to make them highly visible.

	WARNING	Indicates that machine damage could be caused should indications be ignored.
	DANGER	Indicates that machine damage and/or injury to the worker could be caused should indications be ignored.

"**DANGEROUS ZONE**" indicates any zone inside or in the proximity of the appliance in which a person is exposed to the risk of injury or damage to health.

1.03 MACHINE IDENTIFICATION DATA

MODELS:

- LMSM-300/450

PRODUCTION DATA : see EC declaration



1.04 APPLICATIONS

The sieving unit LMSM has been developed for sieving tests on fine and wet materials.

This appliance is for the exclusive use that it has been conceived for.

Any other use is considered improper and therefore negligent.

Machine use is allowed only in places free from danger of explosion or fire.

During operation check for conditions of danger. Immediately stop the machine should it be working irregularly, and consult the authorised dealer's Sales Service department.

It is the Client's responsibility to verify at the time of installation and use that no conditions of use arise which are different to those indicated.

Refer to the Constructor when in doubt



1.05 STORAGE

	WARNING	The appliance must be stored and conserved in the original packaging and in a closed environment, protected from atmospheric agents with a minimum temperature of -15C°, and a maximum of +60C° and a maximum humidity of 70%.
---	----------------	--

1.06 TRANSPORTATION AND MOVEMENT

	WARNING	In order to avoid irreparable machine damage, move with care, do not overturn, protect from rain, do not stack, protect the packaging and its contents from bumps and sources of heat.
---	----------------	--

During transportation and movement it is important to avoid bumps, overloading with other packages, exposure to freezing or heating atmospheric agents, or any other potentially harmful condition to the device, things or people. Machine transportation and movement must be entrusted to Qualified Personnel who can ensure correct movement.

 	DANGER WARNING	Do not transport or move the product should it be impossible to respect the conditions on the packaging or there be any doubts. Request information from the constructor.
---	-----------------------	---

1.07 PACKAGING REMOVAL

After removing the packaging check the machine is complete and that there are no visibly damaged parts. **DO NOT USE THE MACHINE** and refer to the constructor when in doubt.

	DANGER	The components used for packaging (plastic bags, polystyrene, nails, screws, wood, etc) must be kept out of reach of children, as they are sources of danger. These components should be placed in the appropriate containers.
---	---------------	--

	WARNING	In order to avoid bumps and overturn adopt the normal and logical precautions. Before disposing of the packaging check all machine components such as accessories, utensils, instructions, documents etc have been removed.
---	----------------	---

Chapter 2 | TECHNICAL CHARACTERISTICS

2.01 | GENERAL MACHINE DESCRIPTION

The equipment is basically formed by a plate holder for specimens (B5). This is supported by springs (B12) and is activated by electromagnetic impulses (B13). The sieves are subjected to a double vibrating action: vertical and rotational.

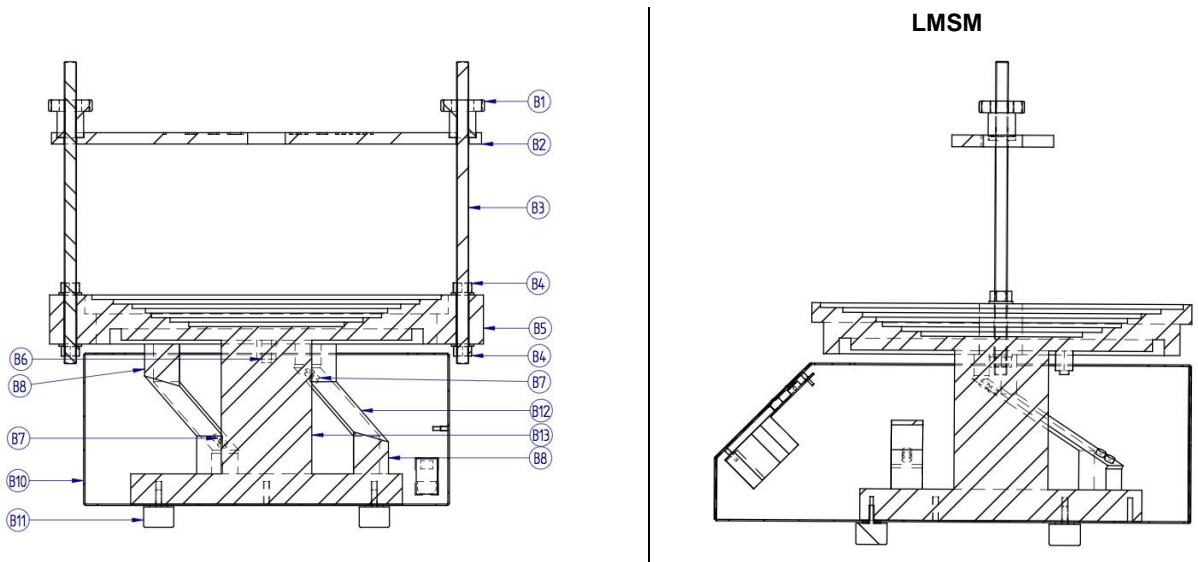

B1	BLOCKING KNOBS	They secure the upper bar (B2) to the sieves, blocking them firmly to the receiver (B5).
B2	BAR	It secures the sieves to the specimen receiver (B5).
B3	THREADED BARS	They allow to regulate the bar height (B2).
B4	FIXING NUTS	They fix the threaded bars (B3) to the specimen receiver. In the shaker A059-01 KIT is present only one pair of data and the bars B2 are screwed into the sieve holder B5
B5	SIEVE HOLDER	It can hold several sieves according to the operator's needs.
B6	ADJUSTMENT SCREWS	They allow to fix and to adjust the specimen receiver (B5) to the electromagnet (B13). In this way, the vibrations produced by the electromagnet are transferred to the sieves placed on the receiver (B5).
B7	FIXING SCREWS	These screws fix the springs (B12) to the support columns (B8).
B8	SUPPORT COLUMN FOR SPRINGS	It allows connecting the base to the specimen receiver (B5) by means of the springs (B12).
B9	CABLE FIXING DEVICE	It fixes the feeling cable to the sieve shaker base, avoiding its incidental pull during the normal working procedures.
B10	GUARD	It allows reaching the inside components of the sieve shaker base. The guard is fixed to the base by some screws.
B11	SUPPORTING FEET	They allow laying the sieve shaker steadily on any surface.
B12	SPRINGS	They transfer the vibrations from the electromagnet (B13) to the specimen receiver (B5).
B13	ELECTROMAGNET	It generates the vibrations, which are necessary for a sieving test. Using the Control Panel (C) it is possible to modify the vibrating intensity according to the user's needs. (See Chapter "USE" of this manual for further details).

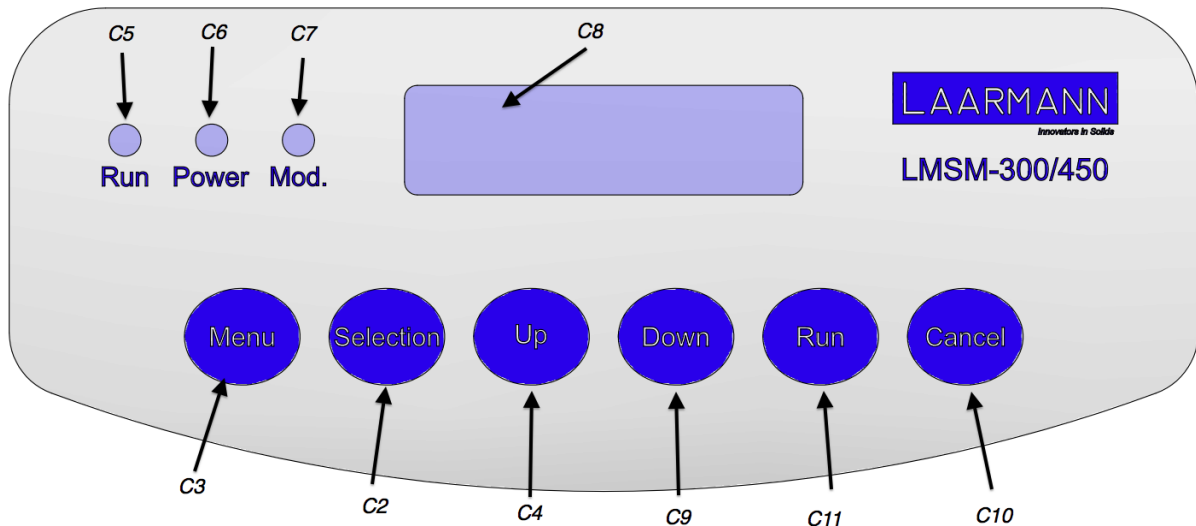

C1	MAIN SWITCH (located on the machine housing)	It allows switching on and off the machine.
C2	“SELECTION” BUTTON	By pressing this key it is possible to select one by one the figures on the right of the numeric display (C8).
C3	“MENU” BUTTON	By pressing this key it is possible to select the working mode of the sieve shaker. This mode is shown by the first figure of the numeric display (C8); See the Chapter “OPERATING MODE” of this manual for further details.
C4	“UP” BUTTON	By pressing this key it is possible to increase the figure shown on the numeric display (C8) in that moment.
C5	LED “RUN”	The lighting of this led means that the machine is vibrating.
C6	LED “POWER”	The lighting of this led means that the sieve shaker is vibrating in the “continuous mode”. For further details, see Charter “SETTING UP” of this manual.
C8	NUMERIC DISPLAY	Using this display it is possible to see all the information referred to the sieve shaker working procedures and also to modify the operating parameters; See the Chapter “USE” of this manual for further details.
C9	“DOWN” BUTTON	By pressing this key it is possible to decrease the figure shown by the numeric display in that moment (C8).
C10	“CANCEL” BUTTON	By pressing this key, the sieving procedure is stopped.
C11	“RUN” BUTTON	By pressing this key, the sieving procedure is activated according to the setting up made by the operator.

2.02 DIMENSION AND WEIGHT

	LMSM 300/450		
LENGTH	500mm		
WIDTH	600mm		
HEIGHT	1150mm		
WEIGHT	90kg		

2.03 ELECTRICAL SUPPLY

VOLTAGE	220-240 V / 100-110 V
FREQUENCY	50 Hz / 60 Hz
POWER	300 VA

2.04 NOISE

The air noise emission levels shown do not necessarily imply the levels of exposure to the worker. The levels of exposure to the operator are obviously linked to the emission levels of the appliance; however other factors influence the levels of exposure to the operator: length of exposure, environmental characteristics, the presence of other machines etc. The appliance emission levels allow anyway an estimate to be carried out on the dangers due to noise.

	DANGER	Continuous use of the appliance and machines predictably present in the installation environment could cause a heightened daily personal exposure to noise.
---	---------------	---

If the daily personal exposure is equal to or more than 85 dB (A) it is advisable to use the Individual Protection Devices (protective headphones, plugs, etc.). If the daily personal exposure is equal to or more than 90 dB (A) it is compulsory to use Individual Protection Devices (protective headphones, plugs, etc.). For further information consult the standards in force in the country of installation.

Average continuous equivalent acoustic pressure level L_{Aeq} to the distance of 1 m 59 dB (A):
 Level of acoustic power emitted by the LWA device 67 dB (A):
 Standard EN ISO 3746

Chapter 3 GENERAL SAFETY STANDARDS

3.01 GENERAL STANDARDS

- To ensure the safety of machine operators:
- Any tampering with the appliance not pre-emptively authorised by the manufacturer exempts the manufacturer from any responsibility for damage caused by or to it.
 - The removal or tampering with safety devices entails a violation of the safety standards.
 - Machine use is only allowed in areas where there is no risk of explosions or fires.
 - Only the original fittings can be used. The use of unoriginal fittings exonerates the manufacturer from all responsibility.
 - Check the appliance is in ideal working conditions and that its parts are not worn or faulty before Carry out all necessary maintenance
 - Do not wear loose clothing, ties, chains or anything else which could become caught in the frame or other moving parts of the appliance.
 - Be aware of the danger of electrical shocks from direct or indirect contact due to unforeseen electrical faults.
 - Do not subject the appliance to violent impact.
 - Do not expose the appliance to fire, welding sparks or extreme temperatures.
 - Do not bring the appliance into contact with corrosive substances.
 - Do not wash the appliance with jets of water.
 - Check the workspace around the machine is clear from potentially dangerous objects.
 - The machine operator must wear appropriate work clothing such as protective glasses, gloves and mask in order to avoid damage from, for example, harmful dust projection. Wear a lower back support when lifting heavy parts. There should be no hanging objects such as bracelets or otherwise, long hair should be protected with relevant precautions, shoes must be appropriate for the type of operation to be carried out.

DURING USE

When operating check there are no conditions of danger. Immediately stop the machine when it is functioning irregularly. Contact the authorised Sales Service department.

- For the operator's safety do not touch any part of the appliance when testing and use the appropriate individual protection devices in order to keep the operator safe.

RISK OR DANGER	SAFETY DEVICE
FINGER OR HANDS SQUEEZING	REINFORCED GLOVES
ABRASIONS OR CUT INJURES	REINFORCED GLOVES
FALL OF MATERIAL	SAFETY SHOES

3.02 MACHINE SAFETY DEVICES AND PROTECTION

DEFINITION: Protections are all the safety measures that consist of the use of specific technical means (repairs, safety devices) to protect people from dangers which cannot be limited reasonably in design.

	<p>DANGER</p>	<p>Tampering with the protections or any appliance modification could cause risks to users or other exposed people.</p> <p>The manufacturer does not assume any responsibility for direct or in direct damage to people, things or animals following tampering with the protections.</p>
---	----------------------	--

On the machine there's the Main Switch (**C1**) also acting as Emergency Switch.

A Guard (optional) can be installed on the machine. This does not allow the operator to touch any moving part of the machine during the test execution. The guard is formed by a wooden box and by an electronic blocking device that disconnects the sieving unit whenever the box is opened during the test running.

Chapter 4 | INSTALLATION INSTRUCTIONS

4.01 | LOCATION

The equipment must be placed in an ideal position and environment for the use it has been conceived for (laboratory use and protected from atmospheric agents) and that a qualified operator places the machine.

ALLOWED TEMPERATURE:	from +5°C to +40°C
ALLOWED RELATIVE HUMIDITY:	from 30% to 70%
MAXIMUM HEIGHT OVER SEA LEVEL:	1000 m

GENERAL ADVICE

- The machine must be installed in an area that allows ease of access to all parts so that maintenance may be carried out.
- Unauthorised people and objects that could be potential sources of danger must not be permitted in the area surrounding the machine.
- Do not position the equipment near instruments or appliances that could produce vibrations.

4.02 | TRANSPORTATION AND MOVEMENT

These instructions are applicable to the machine assemblers.
 Ensure the equipment is correctly supported at the lifting point and that the machine does not slip.
 Do not remain in direct line with the application of force and do not allow personnel where there are loads that cannot be adequately supported by mechanical means.

4.03 | ELECTRICAL CONNECTION

	<p>DANGER</p>	<p>Qualified personnel must carry out wiring of the electrical system.</p> <p>Before wiring consult the electric plan linked to the instructions manual and the registration plate on the machine for information regarding supply, frequency and nominal current.</p> <p>Connect the earthen system via the PE terminal (yellow-green) before any other connection.</p> <p>Apply a knife switch at the top of the connecting cable of the machine to the power system.</p> <p>The knife switch must be combined with a safety device against the overload with a differential switch (safety switch).</p> <p>The technical features of the safety device must be in accordance with the standards in force in the country where the machine has been installed.</p>
---	----------------------	--

ELECTRIC TOLERANCES:

- Real voltage $\pm 10 \%$ of the nominal one
- Frequency: $\pm 1 \%$ of the nominal one in a continuous way
 $\pm 2 \%$ of the nominal one for a short period
- The harmonic distortion of the sum from the second to the fifth harmonics not more than 10 % of the total voltage as a real value between the conductors. A further distortion of 2% is accepted for the sum from the sixth to the thirtieth harmonics of the real total value between the conductors.
- With reference to the voltage imbalance of the three-phase voltage, the inverted sequence component and the zero sequence component must not be more than 2% of the direct sequence component of the voltage.
- The voltage pulses must not last more than 1,5 ms with an up/down time between 500 ms and 500 ms and a peak value not higher than 200 % of the real value of the nominal tension.
- The electric supply must not be interrupted or zeroed for more than 3 ms at any time. Between two interruptions it must not take more than 1 s.

- The interruptions must not overcome 20 % of the tension peak for more than one cycle. Between two interruptions it must not take more than 1 s.

The manufacturer assumes no liability for any damages to people, things and animals caused by the non-compliance of the above instructions

Chapter 5 | IN FUNCTION - USE

	<p>DANGER WARNING</p>	<p>Before setting the machine in motion it is essential that the Operator and Safety Manager have read the Instructions Manual and understood all parts of the machine and activities linked to it (Risks, Dangers, Functionality, Operation, Protections, Commands, etc.)</p>
---	----------------------------------	--

5.01 | MACHINE CALIBRATION – METERS - INDICATORS

The machine is checked in the factory, using sample equipment periodically checked by officially recognised institutes. These checks cannot guarantee that the machine, meters and indicators will provide accurate values and results conforming to the standards in force in the countries the machine has been installed and used in.

Normally such norms envisage calibration check after every movement. In order to obtain correct values and results it is therefore VITAL that the operator, once the machine has been installed and set up and before official tests, has an officially recognised body check the machine characteristics, its calibration and results/values reliability. The manufacturer is exempt from all responsibility in the case of direct and indirect damage from use of the machine without official approval by the relevant bodies.

5.02 | PLACEMENT

For these sieves is important the placement
 The vibrant maximum power can reach values such as to require fixing to the floor of the magnetic shaker.
 If the shaker is used more frequently at low intensity values of vibrant, it is not necessary to fix the shaker to the floor, but if the shaker is used at its most vibrant intensity should be fixed to the floor.

The shaker has 3 brackets with holes for fixing to floor, **to fix the shaker, follow these instructions:**

- **Unscrew the three screws and three washers on the bottom of the shaker.**
- **Interpose the 3 brackets between the bottom of sifter and the screw heads (see diagram opposite),and tighten screws.**
- **Use the outer holes of the brackets to anchor the shaker to the ground.**

N.B.: To anchor the brackets to the floor you must check carefully the floor:

- A. If the floor is very compact and resistant (concrete or similar) is sufficient use of expansion bolts with a penetration depth of 70mm
- B. If the floor has a consistency less than concrete or if is composed by friable materials you must use fixing bolts
 In these cases it is necessary to use fixing bolts anchored to the floor by foundations cemented to the floor.

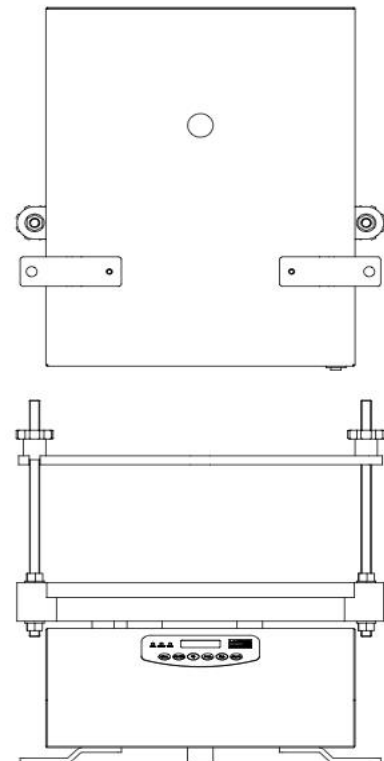

5.03 | EQUIPPING

We give here the right procedures in order which allow to an inexperienced operator tooling up the sieve shaker properly:

INSTALLATION OF THE THREADED RODS

If they were not already screwed, screw the threaded rods (B3) to the sieve holder (B5) paying attention to following instructions:

1. Insert the rods (B3) in their places that are on the sieve holder (B5).

2. Tighten the threaded bars (**B3**) on the sieve holder (**A5**) with the fixing nuts (**B4**), if you have a shaker A071-KIT the rods are screwed on the sieve holder (**A5**) and secured with only two dice.
3. Place the bar (**B2**) to the desired height and lock it with the knobs (**B1**).

SIEVES PREPARATION

Depending from the model the appliance can be used with mesh and perforated plate sieves with following diameters Ø200/250/300/315/450mm and 8" and 12". The sieves must be placed as follows:

1. Position the receiver (not perforated sieve used to collect material) in the middle of the sieve holder (**B5**).
2. Add on the receiver the sieves, paying attention to start on the bottom with the sieves having the smallest openings and continue with the bigger ones
3. At the end add the cover (lid) and fix the series of sieves strongly using the upper blocking bar (**B2**) introduced in the two bars fitted on the vibrating plate.

The system to fit the sieves and the upper bar of the sieves, allows also fitting a lid and receiver for wet tests.

	WARNING	Before proceeding to the normal use of the appliance be sure that all the parts are properly tooled up and are suitable for the test that has to be made.
---	----------------	---

5.04 SPECIMEN POSITIONING

	WARNING	Before starting a test, ensure that the sieves on the machine are convenient for the specimen you are going to test. (See chapter "TOOLING UP").
---	----------------	--

The material positioning can be done in many different ways depending on the kind of test you want to perform.

For a correct specimen preparation and positioning, please read carefully the standards in force for the kind of test you wish to perform.

5.05 SWITCHING ON THE EQUIPMENT

	ATTENZIONE	Before switching on the appliance, ensure that the sieve shaker is connected to the feeding net. (Consult the chapter "ELECTRIC CONNECTIONS" of this manual).
---	-------------------	---

To switch on the machine follow these instructions:

- Put the Main Switch (**C1**) on the "0" position.

At this step the sieve shaker is ready for the set up and for the use; on the display (**C8**) the operator will see for a few seconds the code referred to the machine model and then following picture **6.3-I**.

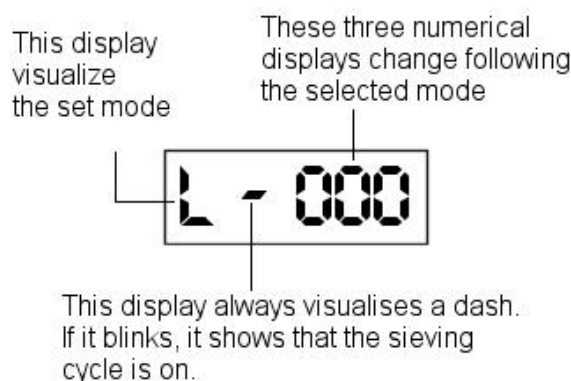

PICTURE 6.3-1

When the machine is switched on, the program opens in L mode and on the numeric display (**C8**) the operator must enter the set up values used during the latest effected test.

In case these values are not proposed again or the above picture is not shown after the switching on, please contact immediately our After Sale Service, since this could represent a bad working of the sieve shaker.

5.06 OPERATING MODE

The working mode of the sieve shaker is visualised on the numerical display (C8) as specified in **figure 6.3-I** (for the decoding of the visualised value consult the list here below).

MODE	DESCRIPTION	SETTABLE VALUES
L	Indication of the remaining time to the end of the test	---
T	Indication or selection of the sieving time	1 – 999 min.
H	Indication or selection of the vibrating intensity	0 – 99
F	Indication or selection of the ON time	1 – 999 sec.
C	Indication or selection of the sieving mode	0 = Intermittent 1 = Continue

5.07 SWITCHING THE APPLIANCE ON

By pressing this key, the sieving procedure is activated according to the setting up made by the operator.

5.08 SWITCHING OFF

At the end of a test cycle, follow these instructions in order to switch off the appliance:



1. Remove all the sieves and thoroughly clean the appliance from any possible specimen residual.
2. To switch off the appliance, put the Main Switch (C1) on the "0" position.

5.09 EMERGENCY STOP

Whenever it is necessary the operator can stop the test immediately by positioning the Main Switch (C1) on "0".

	WARNING	Remind that the test interruption causes its complete cancellation.
---	----------------	---

5.10 START UP AFTER EMERGENCY

 	WARNING DANGER	Before starting the machine up again, find and solve the problem, which led to an emergency stop.
---	---------------------------	---

To start the machine, put the Main Switch (C1) on the "1" position. This will reset the appliance to its standard functions.

5.11 PROGRAMMING

	WARNING	Do not try to operate the appliance without having carefully read and learnt this manual in all its parts.
---	----------------	--









The sieve shaker has been studied in order to satisfy any operator's need by means of its easy and accurate setting procedures. The parameters that can be modified are:

- Sieving intensity
- Sieving time
- Sieving mode

For a correct set up please follow with great care our instructions:

SIEVING INTENSITY

The Sieving intensity can be varied entering a value from 0 to 99 on the display.





1. Press several times the key  until on the numeric display (C8) appears the letter H (set up mode referred to the sieving intensity).
2. Press the key . The middle dash of the numeric display (C8) will start lighting.
3. Press the key  to increase the value or the key  to decrease it. The led is now blinking showing that the value is under modification.
4. Press the key  until the figure on the right is blinking.
5. Press the key  to increase the value or the key  to decrease it.
6. Press several times the key  until you come back to mode L (residual time to end the test). Confirming the data storing, the led will stop blinking.





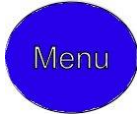

	WARNING	<p>The intensity of the sieving must not be set over the values that may cause the bumping up to the end of scale of the electromagnet (this condition can be recognized by a marked metallic noise)</p> <p>If this condition is shown, reduce the intensity of the sieving until the unusual noise disappears</p> <p>The non-respect of such shrewdness may cause the braking of some components of the sieve-shaker (springs and electromagnet) and successively the decay of the WARRANTY term</p>
---	----------------	--

	WARNING	Be sure to set the intensity of sieving before initiating the screening, or the shaker may not start.
---	----------------	---

SIEVING TIME

Setting up a value from 1 to 999 minutes can vary the sieving period on the display.

1. Press several times the key  until on the numeric display (C8) appears the letter t (indicating the sieving time or the possibility to select it).
2. Press the key . The figure on the left of the display (C8) will start blinking.
3. Press the key  to increase the value or the key  to decrease it. The led is now blinking, showing that the value is under modification.

4. Press the key  until the middle figure of the display (**C8**) starts blinking.
5. Press the key  to increase the value or the key  to decrease it.
6. Press the key  until the figure on the right of the display (**C8**) starts blinking.
7. Press the key  to increase the value or the key  to decrease it.
8. Press several times the key  until you come back to mode **L** (residual time to end the test). Confirming the data storing, the led will stop blinking.







SIEVING MODE









The sieving procedure can be selected either in intermittent or continuous way.

INTERMITTENT SIEVING

Every pause lasts 2 seconds (OFF time).





The vibration period between two pauses (ON time) can be varied by setting on the display a value from 1 to 999 seconds:

1. Press several times the key  until on the numeric display (**C8**) appears letter **C** (showing present sieving mode or possibility to select it).
2. Press the key . The figure on the numeric display (**C8**) shall blink.
3. Press the key  to increase the value or the key  to decrease it. The led is now blinking, showing that the value is under modification.
4. Press several times the key  until you come back to mode **L** (residual time to end the test). Confirming the data storing, the led will stop blinking.
5. Press several times the key  until on the numeric display (**C8**) appears the letter **F** (showing ON time or the possibility to select it).
6. Press the key ; the figure on the left of the display (**C8**) will start blinking.

7. Press the key  to increase the value or the key  to decrease it. The led is now blinking, showing that the value is under modification.
8. Press the key  ; the figure in the middle of the display (**C8**) will start blinking.
9. Press the key  to increase the value or the key  to decrease it. The led is now blinking, showing that the value is under modification.
10. Press the key  ; the figure on the right of the display (**C8**) will start blinking.
11. Press the key  to increase the value or the key  to decrease it. The led is now blinking, showing that the value is under modification.
12. Press several times  until you come back to mode **L** (residual time to end the test). Confirming the data storing, the led will stop blinking.

CONTINUOUS SIEVING

Press several times the key  until on the numeric display (**C8**) appears the letter **C** (showing the present mode or the possibility to select it):

1. Press the key  . The figure on the numeric display (**C8**) shall blink.
2. Press the key  to increase the value or the key  to decrease it and to set up the value 1. The led is now blinking, showing that the value is under modification.
3. Press several times the key  until you come back to mode **L**. Confirming the data storing, the led stops blinking.

NOTE	In the intermittent mode, the total sieving period includes the pauses too. If the user selects a sieving time of 10 minutes, the appliance will stop working after 10 minutes, either in the intermittent or in the continuous mode.
-------------	--

5.12 TEST START UP

Before using the appliance regularly check it is working correctly by carrying out at least one complete empty cycle according to the previous instructions.
Should there be any problem consult the chapter "DIAGNOSTICS".
If the instructions in this manual do not provide the solution to the problem, contact Sales Assistance.

Chapter 6 MAINTENANCE

6.01 ORDINARY MAINTENANCE

	<p>DANGER WARNING</p>	<p>Do not perform maintenance – interventions on the machine which have not been quoted and described in this instructions manual without first contacting the manufacturer. Periodically clean all machine parts and oil the unpainted parts in order to preserve the machine and its efficiency. Avoid the use of solvents which damage paint and parts in synthetic material.</p>
---	----------------------------------	--

6.02 EXTRAORDINARY MAINTENANCE

REPLACEMENT OF THE SPRINGS

If one or more than one of the springs (B12) breaks, replace it paying attention to following instructions:

1. Turn off the appliance and disconnect it from the main.
2. Disassemble the threaded rods (B3) used to fix the sieves from the sieve holder (B5).
3. Open the cable-fixing device (B9) and push it inside for about 5-10 cm.
4. Turn upside down the sieve shaker (180°), leaning it on the sieve holder.
5. Disassemble the feet (B11) from the base and unscrew the screws fixing the frame (B10).
6. Disassemble the frame (B10) and let it slide along the cable in order not to have it disturbing the following operations.
7. Assemble the feet (B11) directly on the base and turn it again upside down (180°) paying attention to lean it on the feet.
8. Unscrew the fixing screws (B7) and remove the damaged springs.
9. Install the new springs (B12) and fix them as the previous ones, paying attention to close strongly all the screws.
10. Install again the carter (B10) following the operations described above here from the end to the beginning.

6.03 AUTHORISED MAINTENANCE CENTRES

For information on the nearest authorised help centre it is essential to contact the manufacturer.

Chapter 7 GUIDE TO RECOGNISING DAMAGE AND ANOMALIES

This chapter presents and discusses all the simple problems which could occur during machine use. The appropriately qualified, professional personnel must carry out all the maintenance procedures, check and control, as well as all the repair operations on parts of the machine or the electrical system. Contact Technical Sales Assistance for any other problem not listed on the previous table or should the malfunctioning persist after the intervention of the operator in accordance with the previously mentioned courses of action.

FAILURE	POSSIBLE CAUSE	CURE
After operating the Main Switch, The machine does not start.	No supply	Verify the correct use of the Main Switch (C4) Verify the Main in the control panel
	Fuses are broken	Replace the fuses with the new fuses having the same capacity. The fuses are on the electronic card inside the switch board.
After a correct set up of the sieve shaker, pressing the button (C11) the electro magnet does not work	Failure to the electric system	Check if the wires and the connections of the electric circuit are interrupted.
	Failure to the electromagnet	Contact our After Sale Service

Ensure all machine parts are in safe working order before operating it again should the machine be inactive for a long period of time. When in doubt contact the Manufacturer.